

SPECIFICATION FOR APPROVAL

REF : 20090506-B

PAGE: 1

PROD. NAME	SHIELDED SMD POWER INDUCTOR	ABC'S DWG NO. ABC'S ITEM NO.	SH4028□□□□L□-□□□
---------------	--------------------------------	---------------------------------	------------------

I . CONFIGURATION & DIMENSIONS :

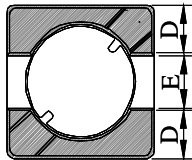
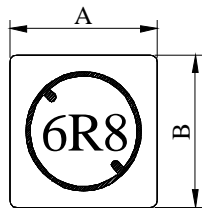

- A : 4.80±0.2 m/m
- B : 4.80±0.2 m/m
- C : 2.80±0.2 m/m
- D : 1.60 typ. m/m
- E : 1.60 typ. m/m
- G : 1.50 ref. m/m
- H : 5.30 ref. m/m
- I : 2.00 ref. m/m
- R : 1.80 ref. m/m

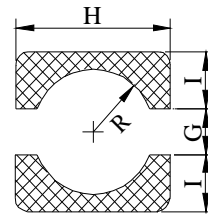

(PCB Pattern suggestion)

II . SCHEMATIC DIAGRAM :

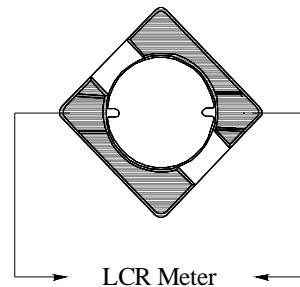
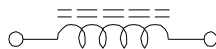

III . MATERIALS :

- a . Core : Ferrite DR core
- b . Core : Ferrite RI core
- c . Wire : Enamelled copper wire (Class F & H)
- d . Adhesive : Epoxy resin
- e . Terminal : Ag/Ni/Sn
- f . Remark : Products comply with RoHS' requirements

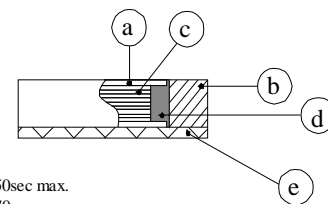

Peak Temp : 260°C max.
 Max time above 230°C : 50sec max.
 Max time above 200°C : 70sec max.

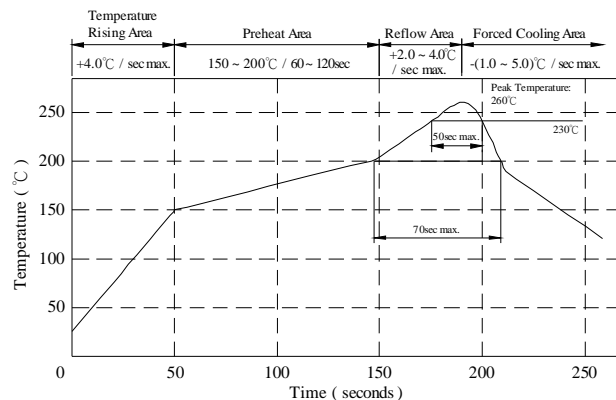

IV . GENERAL SPECIFICATION :

- a . Temp. rise : 30°C max.
- b . Storage temp. : -40°C ----+125°C
- c . Operating temp. : -40°C ----+105°C
- d . Resistance to solder heat : 260°C .10 secs.

AR-001A

SPECIFICATION FOR APPROVAL

REF : 20090506-B

PAGE: 2

PROD.	SHIELDED SMD	ABC'S DWG NO.	SH4028□□□□L□-□□□
NAME	POWER INDUCTOR	ABC'S ITEM NO.	

V . ELECTRICAL CHARACTERISTICS :

DWG No.	Inductance (μ H)	SRF (MHz) typ.	RDC (m Ω)		Irms (mA) max.	Isat (mA) typ.
			typ.	max.		
SH40281R2YL□-□□□	1.2 \pm 30%	143.0	13.0	20.0	3100	2560
SH40281R8YL□-□□□	1.8 \pm 30%	117.0	16.0	25.0	2700	2200
SH40282R2YL□-□□□	2.2 \pm 30%	90.0	20.0	28.0	2500	2050
SH40282R7YL□-□□□	2.7 \pm 30%	88.0	22.0	30.0	2350	1800
SH40283R3YL□-□□□	3.3 \pm 30%	77.0	26.0	35.0	2150	1650
SH40283R9YL□-□□□	3.9 \pm 30%	79.0	42.0	60.0	1720	1500
SH40284R7YL□-□□□	4.7 \pm 30%	42.0	47.0	70.0	1550	1300
SH40285R6YL□-□□□	5.6 \pm 30%	68.0	65.0	85.0	1380	1200
SH40286R8YL□-□□□	6.8 \pm 30%	58.0	70.0	90.0	1300	1150
SH40288R2YL□-□□□	8.2 \pm 30%	45.0	76.0	100.0	1250	1050
SH4028100YL□-□□□	10.0 \pm 30%	30.0	86.0	110.0	1190	1000
SH4028120YL□-□□□	12.0 \pm 30%	29.0	95.0	125.0	1120	850
SH4028150YL□-□□□	15.0 \pm 30%	30.0	115.0	150.0	1030	780
SH4028180YL□-□□□	18.0 \pm 30%	27.0	128.0	160.0	980	750
SH4028220YL□-□□□	22.0 \pm 30%	23.0	144.0	185.0	925	720
SH4028270YL□-□□□	27.0 \pm 30%	18.0	156.0	200.0	890	600
SH4028330YL□-□□□	33.0 \pm 30%	16.0	183.0	230.0	820	580
SH4028390YL□-□□□	39.0 \pm 30%	20.0	196.0	250.0	795	500
SH4028470YL□-□□□	47.0 \pm 30%	10.0	218.0	280.0	750	480
SH4028560YL□-□□□	56.0 \pm 30%	11.0	250.0	320.0	700	410
SH4028680YL□-□□□	68.0 \pm 30%	13.0	310.0	400.0	630	360
SH4028820YL□-□□□	82.0 \pm 30%	9.8	395.0	520.0	560	320
SH4028101YL□-□□□	100.0 \pm 30%	10.0	476.0	600.0	510	300
SH4028121YL□-□□□	120.0 \pm 30%	8.8	555.0	700.0	470	280
SH4028151YL□-□□□	150.0 \pm 30%	6.8	685.0	860.0	420	260
SH4028181YL□-□□□	180.0 \pm 30%	6.7	778.0	1000.0	390	230
SH4028221YL□-□□□	220.0 \pm 30%	6.1	1008.0	1250.0	340	200
SH4028271YL□-□□□	270.0 \pm 30%	4.3	1192.0	1500.0	320	180
SH4028331YL□-□□□	330.0 \pm 30%	4.3	1338.0	1700.0	300	170
SH4028391YL□-□□□	390.0 \pm 30%	3.9	1798.0	2200.0	260	160
SH4028471YL□-□□□	470.0 \pm 30%	2.9	2128.0	2600.0	240	155
SH4028561YL□-□□□	560.0 \pm 30%	3.0	2478.0	3000.0	220	150

- 1). □ : Packaging Information... Bulk Taping Reel
- 2). "- □□□": Reference code
- 3). Inductance Test Freq. : 100KHz /0.1V
- 4). Irms base on Temp. rise 30°C max.
- 5). Isat base on Δ L/L0A=35% typ.

AR-001A



SPECIFICATION FOR APPROVAL

REF : 20090506-B

PAGE: 3

PROD.	SHIELDED SMD	ABC'S DWG NO.	SH4028□□□□L□-□□□
NAME	POWER INDUCTOR	ABC'S ITEM NO.	

VI . INDUCTANCE VS. DC CURRENT CURVE :

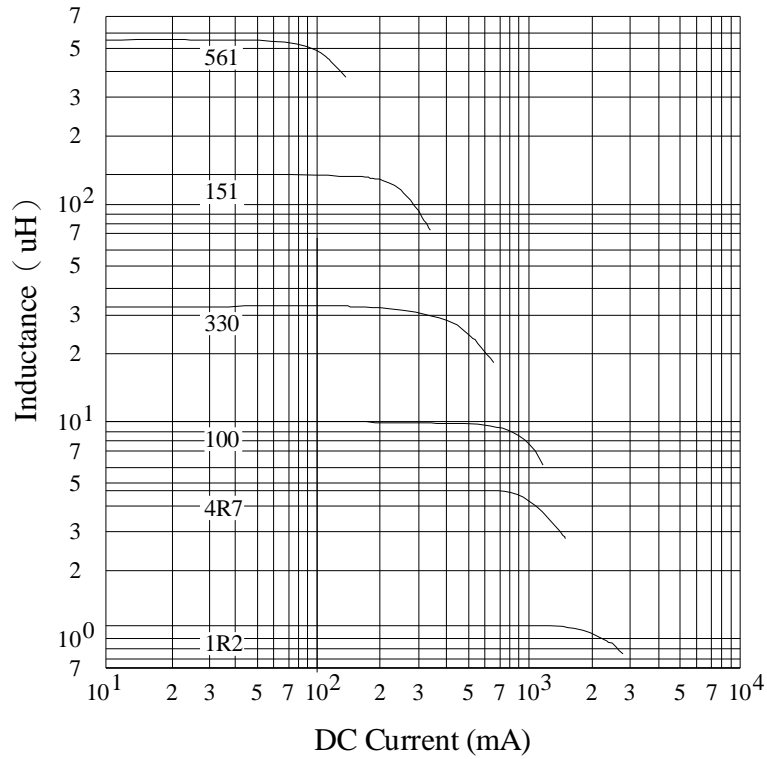

SPECIFICATION FOR APPROVAL

REF : 20090506-B

PAGE: 4

PROD. NAME	SHIELDED SMD POWER INDUCTOR	ABC'S DWG NO.	SH4028□□□□L□-□□□
		ABC'S ITEM NO.	

VII . PACKAGING INFORMATION :

(1) Configuration

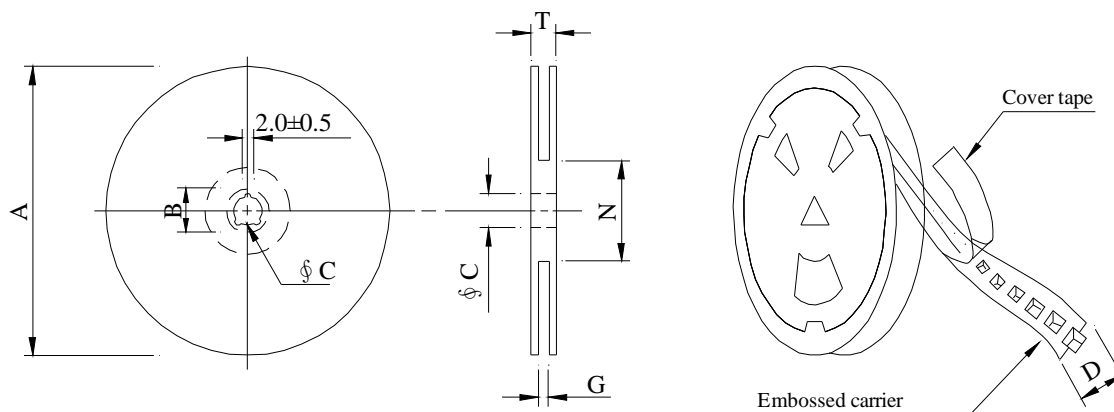

※Carrier tape width : D

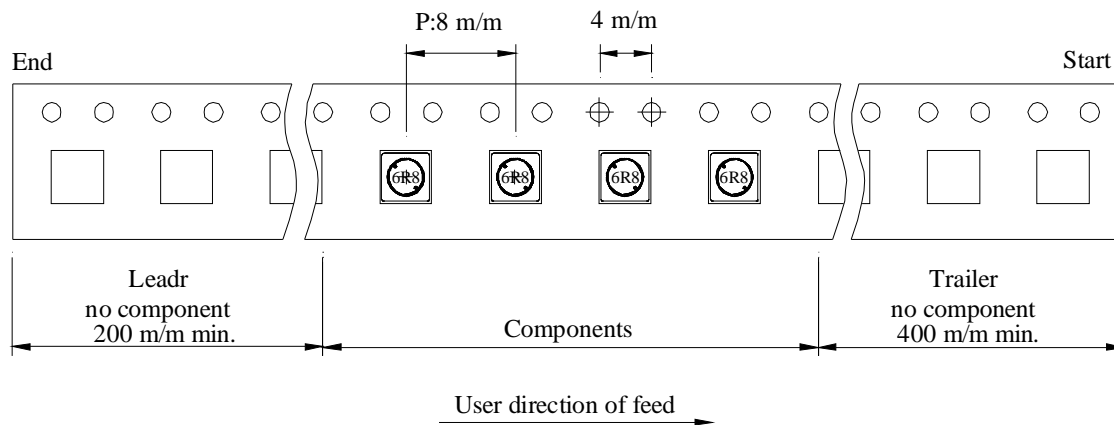

(2) Dimensions

Unit:m/m

Style	A	B	C	D	G	N	T
07 - 12	178	21±0.8	13	12	14 ⁺⁰	50 ⁻⁰	16.5
13 - 12	330	21±0.8	13±0.5	12	14 ⁺⁰	50 ⁻⁰	18.4

(3) Q'TY & G.W. Per package

Series	Inner : Reel			Outer : Carton		
	Q'TY (pcs)	G.W. (gw)	Style	Q'TY (pcs)	G.W. (Kg)	Size (cm)
SH4028	500	220	07 - 12	20,000	6.50	42 x 41 x 24
SH4028	2,000	880	13 - 12	16,000	5.30	40 x 40 x 24

AR-001A

SPECIFICATION FOR APPROVAL

REF : 20090506-B

PAGE: 5

PROD. NAME	SHIELDED SMD POWER INDUCTOR	ABC'S DWG NO. ABC'S ITEM NO.	SH4028□□□□L□-□□□
---------------	--------------------------------	---------------------------------	------------------

VIII . DWGING NUMBER EXPRESSION :

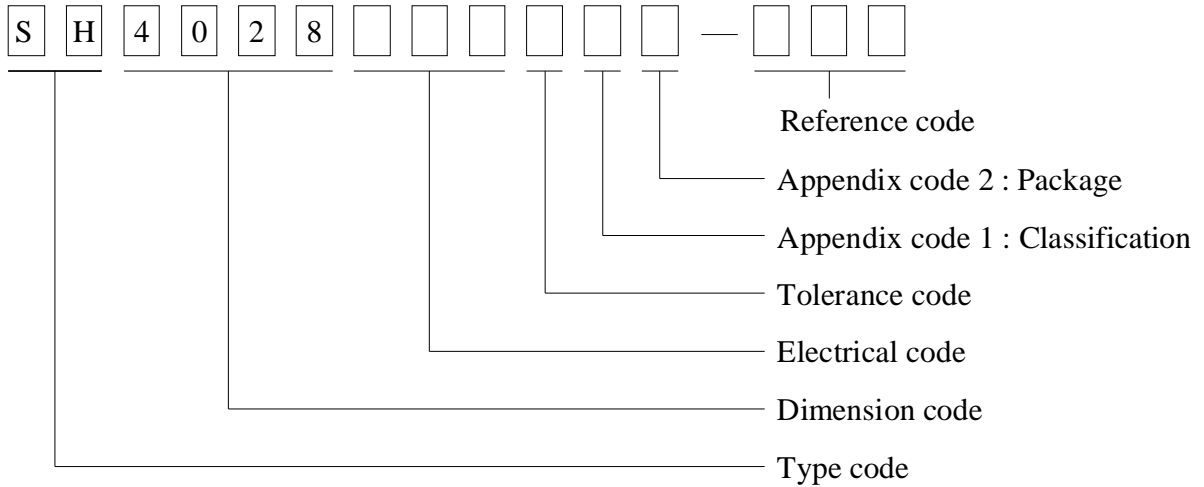

Appendix code 1 : Product Classification

- L : Lead Free Standard products comply with RoHS' requirements
- 1 ~ 9 : Lead Free Special products comply with RoHS' requirements

Appendix code 2 : Package Information

Code	Inner package	Inner package Q'TY	Remark
A	T.B.D.	T.B.D.	
B	T / R (Reel package)	500 pcs	
C	T / R (Reel package)	2000 pcs	

SPECIFICATION FOR APPROVAL

REF : 20090506-B

PAGE: 6

PROD. NAME	SHIELDED SMD POWER INDUCTOR	ABC'S DWG NO.	SH4028□□□□L□-□□□
		ABC'S ITEM NO.	

IX . RELIABILITY TEST :

Test item	Specification	Test condition						
Solderability	More than 95% of the terminal electrode shall be covered With fresh solder.	Preheat : 155°C / 4 hours. Solder : Sn96.5 / Ag3 / Cu0.5 or equivalent Solder temp. : 235±5°C Flux : Rosin Dip time : 5±0.5 seconds						
Thermal shock test (Temp. cycle)	Electrical oharacteristics shall not change more than ±20%	<table style="width: 100%; border: none;"> <tr> <td style="text-align: center;">Room temp. 15 minutes</td> <td style="text-align: center;">→</td> <td style="text-align: center;">-40 °C 30 minutes</td> </tr> <tr> <td style="text-align: center;">Room temp. 15 minutes</td> <td style="text-align: center;">→</td> <td style="text-align: center;">+105 °C 30 minutes</td> </tr> </table> <p>Total : 50 cycles</p>	Room temp. 15 minutes	→	-40 °C 30 minutes	Room temp. 15 minutes	→	+105 °C 30 minutes
Room temp. 15 minutes		→	-40 °C 30 minutes					
Room temp. 15 minutes		→	+105 °C 30 minutes					
Humidity test		Temperature : 40±2°C Humidity : 90±5% Time : 1000 hours						
High temp. Resistance test	Temperature : 105±5°C Applied current : Per spec. Time : 96 hours							

SPECIFICATION FOR APPROVAL

REF : 20090506-B

PAGE: 7

PROD. NAME	SHIELDED SMD POWER INDUCTOR	ABC'S DWG NO.	SH4028□□□□L□-□□□
		ABC'S ITEM NO.	

X . UL CARD :

OBMW2 September 8, 2000

Magnet Wire-Component

JUNG SHING WIRE CO LTD E174837

231 CHUNG CHENG RD, SEC 3 JEN-TEH HSIANG, TAINAN
HSIEN TAIWAN

Mtl Dsg	Mark Dsg	BC	Coat Typ	OC	ANSI Type	Temp Class
AIW	---	Polyamideimide	---	---	MW81-C	220
CFUEWB	---	Polyurethane	---	---	MW75C	130
EIAIW	---	Polyesterimide	Polyamideimide	---	MW35C	200
EILOCKY	---	Polyesterimide	Polyamide	---	---	180
EILOCKW	---	Polyesterimide	Modified Epoxy	---	---	200
EIW	---	Polyesterimide	---	---	---	220
EIW-2	---	Polyesterimide	---	---	MW74-C	200
FL.EILOCKY	---	Modified Polyester	Polyamide	---	---	155
LSFFW	---	Polyurethane	---	---	MW79-C	155
LSUEW	---	Polyurethane	---	---	---	130
PEW	---	Polyester	---	---	---	155
PEY	---	Polyester	Nylon	---	MW24-C	155
SF.FLW	---	Modified Polyester	---	---	MW26C	155
SF.EIW	---	Polyesterimide	---	---	MW77C	180
SF.BY@	---	Modified Polyester	Nylon	---	MW27-C	155
SF.FLY@	---	Modified Polyester	Nylon	---	MW27-C	155
SF.BLOCKBS	---	Modified Polyester	Modified Polyamide	---	---	155
SF.EILOCKY#	---	Polyesterimide	Polyamide	---	---	180
SF.EILOCKBS	---	Polyesterimide	Modified Polyamide	---	---	180
SF.BW@	---	Modified Polyester	---	---	MW26C	155
SFFW	---	Polyurethane	---	---	MW79	155

287806002 Page 1 of 2

A not-for-profit organization dedicated to public safety and committed to quality service

Mtl Dsg	Mark Dsg	BC	Coat Typ	OC	ANSI Type	Temp Class
SFFY	---	Polyurethane	Polyamide	---	MW80C	155
UEW-1	---	Polyurethane	---	---	MW2-C	105
UEW-2	---	Polyurethane	---	---	---	130
UEW-4	---	Polyurethane	---	---	MW75C	130
UEY	---	Polyurethane	Nylon	---	MW28-C	130
UEY-2	---	Polyurethane	Polyamide	---	MW28-C	130

@-May be suffixed by LZ; # - May be suffixed by LZ, EL or LZL.
LZ - Signifies magened wires twisted together; EL - signifies base coated magnet wire laid parallel with top coat applied overall; LZL - signifies base coated magnet wire twisted together and covered with top coat overall.

Marking: Company name or trademarks or 榮星電線 , material designation or marked designation on packaed or reel, and Recognized Component Mark.

See General Information Preceding These Recognitions
For use only in equipment where the acceptability of the combination is determined by Underwriters Laboratories Inc.

287806002 Page 2 of 2

OBMW2/E174837
September 8, 2000